

**PLEASE CHECK WWW.MOLEX.COM FOR LATEST PART INFORMATION**

**Part Number:** [0901362230](#)  
**Status:** **Active**  
**Overview:** [cgrid\\_iii](#)  
**Description:** 2.54mm (.100") Pitch C-Grid III™ Header, Single Row, Right Angle, Shrouded, 30 Circuits, 0.38µm (15µ") Gold (Au) Selective Plating

**Documents:**

[3D Model](#) [RoHS Certificate of Compliance \(PDF\)](#)  
[Drawing \(PDF\)](#)

**General**

Product Family	PCB Headers
Series	<a href="#">90136</a>
Application	Wire-to-Board
Overview	<a href="#">cgrid_iii</a>
Product Name	C-Grid III™

**Physical**

Breakaway	No
Circuits (Loaded)	30
Circuits (maximum)	30
Color - Resin	Black
First Mate / Last Break	No
Glow-Wire Compliant	No
Guide to Mating Part	No
Keying to Mating Part	None
Lock to Mating Part	Yes
Material - Metal	Brass
Material - Plating Mating	Gold
Material - Plating Termination	Tin
Material - Resin	Polyester
Number of Rows	1
Orientation	Right Angle
PC Tail Length (in)	0.114 In
PC Tail Length (mm)	2.90 mm
PCB Locator	No
PCB Retention	None
PCB Thickness Recommended (in)	0.062 In
PCB Thickness Recommended (mm)	1.60 mm
Packaging Type	Tray
Pitch - Mating Interface (in)	0.100 In
Pitch - Mating Interface (mm)	2.54 mm
Plating min: Mating (µin)	15.2
Plating min: Mating (µm)	0.38
Plating min: Termination (µin)	120
Plating min: Termination (µm)	3
Polarized to PCB	No
Shrouded	Fully
Stackable	No
Temperature Range - Operating	-55°C to +125°C
Termination Interface: Style	Through Hole

**Electrical**

Current - Maximum per Contact	3A
Voltage - Maximum	350V



**EU RoHS**

**ELV and RoHS Compliant**  
**REACH SVHC Not Reviewed**  
**Halogen-Free Status Not Reviewed**

**China RoHS**



**Need more information on product environmental compliance?**

Email [productcompliance@molex.com](mailto:productcompliance@molex.com)  
 For a multiple part number RoHS Certificate of Compliance, [click here](#)

Please visit the [Contact Us](#) section for any non-product compliance questions.

**Search Parts in this Series**

[90136Series](#)

**Mates With**

[90123 C-Grid III™ Modular Crimp Housing.](#)  
[90156 C-Grid III™ Crimp Housing](#)

**Material Info**

**Reference - Drawing Numbers**

Packaging Specification

Sales Drawing

PK-90136-001

SDA-90136

This document was generated on 05/26/2010

**PLEASE CHECK [WWW.MOLEX.COM](http://WWW.MOLEX.COM) FOR LATEST PART INFORMATION**



1 TO 3 CIRCUITS

4 TO 32 CIRCUITS



SECTION K-K

No. OF CKTS	DIM A	DIM B	DIM C
1		( 5.89 ) / .232	( 4.06 ) / .160
2	( 2.54 ) / .100	( 8.43 ) / .332	( 6.60 ) / .260
3	( 5.08 ) / .200	( 10.97 ) / .432	( 9.14 ) / .360
4	( 7.62 ) / .300	( 13.51 ) / .532	( 11.68 ) / .460
5	( 10.16 ) / .400	( 16.05 ) / .632	( 14.22 ) / .560
6	( 12.70 ) / .500	( 18.59 ) / .732	( 16.76 ) / .660
7	( 15.24 ) / .600	( 21.13 ) / .832	( 19.30 ) / .760
8	( 17.78 ) / .700	( 23.67 ) / .932	( 21.84 ) / .860
9	( 20.32 ) / .800	( 26.21 ) / 1.032	( 24.38 ) / .960
10	( 22.86 ) / .900	( 28.75 ) / 1.132	( 26.92 ) / 1.060
11	( 25.40 ) / 1.000	( 31.29 ) / 1.232	( 29.46 ) / 1.160
12	( 27.94 ) / 1.100	( 33.83 ) / 1.332	( 32.00 ) / 1.260
13	( 30.48 ) / 1.200	( 36.37 ) / 1.432	( 34.54 ) / 1.360
14	( 33.02 ) / 1.300	( 38.91 ) / 1.532	( 37.08 ) / 1.460
15	( 35.56 ) / 1.400	( 41.45 ) / 1.632	( 39.62 ) / 1.560
16	( 38.10 ) / 1.500	( 43.99 ) / 1.732	( 42.16 ) / 1.660
17	( 40.64 ) / 1.600	( 46.53 ) / 1.832	( 44.70 ) / 1.760
18	( 43.18 ) / 1.700	( 49.07 ) / 1.932	( 47.24 ) / 1.860
19	( 45.72 ) / 1.800	( 51.61 ) / 2.032	( 49.78 ) / 1.960
20	( 48.26 ) / 1.900	( 54.15 ) / 2.132	( 52.32 ) / 2.060
21	( 50.80 ) / 2.000	( 56.69 ) / 2.232	( 54.86 ) / 2.160
22	( 53.34 ) / 2.100	( 59.23 ) / 2.332	( 57.40 ) / 2.260
23	( 55.88 ) / 2.200	( 61.77 ) / 2.432	( 59.94 ) / 2.360
24	( 58.42 ) / 2.300	( 64.31 ) / 2.532	( 62.48 ) / 2.460
25	( 60.96 ) / 2.400	( 66.85 ) / 2.632	( 65.02 ) / 2.560
26	( 63.50 ) / 2.500	( 69.39 ) / 2.732	( 67.56 ) / 2.660
27	( 66.04 ) / 2.600	( 71.93 ) / 2.832	( 70.10 ) / 2.760
28	( 68.58 ) / 2.700	( 74.47 ) / 2.932	( 72.64 ) / 2.860
29	( 71.12 ) / 2.800	( 77.01 ) / 3.032	( 75.18 ) / 2.960
30	( 73.66 ) / 2.900	( 79.55 ) / 3.132	( 77.72 ) / 3.060
31	( 76.20 ) / 3.000	( 82.09 ) / 3.232	( 80.26 ) / 3.160
32	( 78.74 ) / 3.100	( 84.63 ) / 3.332	( 82.80 ) / 3.260

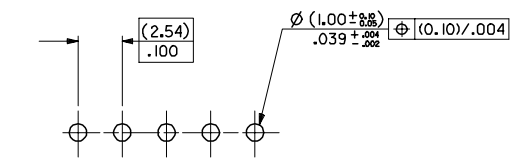

RECOMMENDED P.C. BOARD HOLE PATTERN

- NOTES
- MATERIAL:-
    - PIN:- (0.635) / .025 SQ.BRASS WIRE.
    - HOUSING:- 15% GLASS FILLED POLYESTER
    - UL 94 V-0 COLOUR BLACK
  - FOR PLATING VERSIONS SEE SHEET 2.
  - MEASUREMENT POINT FOR MINIMUM PLATING THICKNESS
  - PRODUCT SPEC: PS-99020-0001
  - RECOMMENDED PCB THICKNESS 1.6mm

ADDED CIRCUIT 1 INDICATOR E.C. NO: E2008-0112 DRAWN BY: BRYANES CHKD: 2007/09/10 APPR: WALLACE 2007/09/11	QUALITY SYMBOLS ▽=0 ▽=0	GENERAL TOLERANCES (UNLESS SPECIFIED)		DIMENSION STYLE MM/IN	SCALE 5:1	DESIGN UNITS METRIC	THIRD ANGLE PROJECTION
		4 PLACES ± --- ± --- 3 PLACES ± --- ± .004 2 PLACES ± 0.10 ± --- 1 PLACE ± --- ± --- ANGULAR ± 1/2°	mm INCH	DRAWN BY KS	DATE 1987/10/30	TITLE C-GRID III SINGLE ROW STRAIGHT SHROUDED HEADER	
REV N	DESCRIPTION	DRAFT WHERE APPLICABLE MUST REMAIN WITHIN DIMENSIONS		CHECKED BY DATE	APPROVED BY DATE	MOLEX INCORPORATED	
		SEE CHART		MATERIAL NO.	DOCUMENT NO.	SDA-90136	
				THIS DRAWING CONTAINS INFORMATION THAT IS PROPRIETARY TO MOLEX INCORPORATED AND SHOULD NOT BE USED WITHOUT WRITTEN PERMISSION		SHEET NO. 1 OF 100	

13 12 11 10 9 8 7 6 5 4 3 2 1

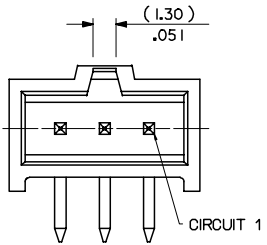

1 TO 3 CIRCUITS

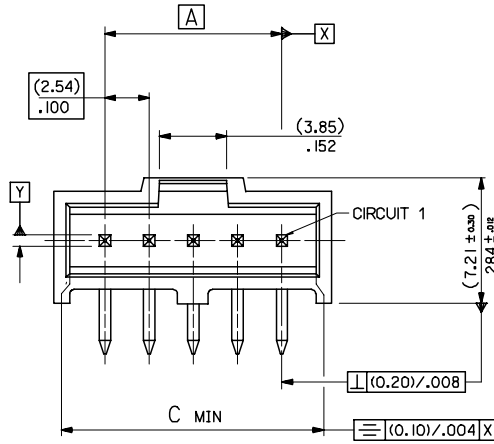

4 TO 32 CIRCUITS

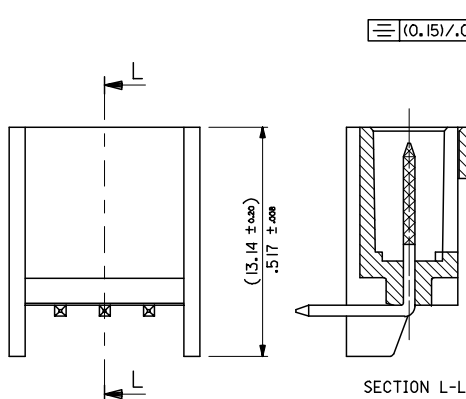

1 TO 6 CIRCUITS

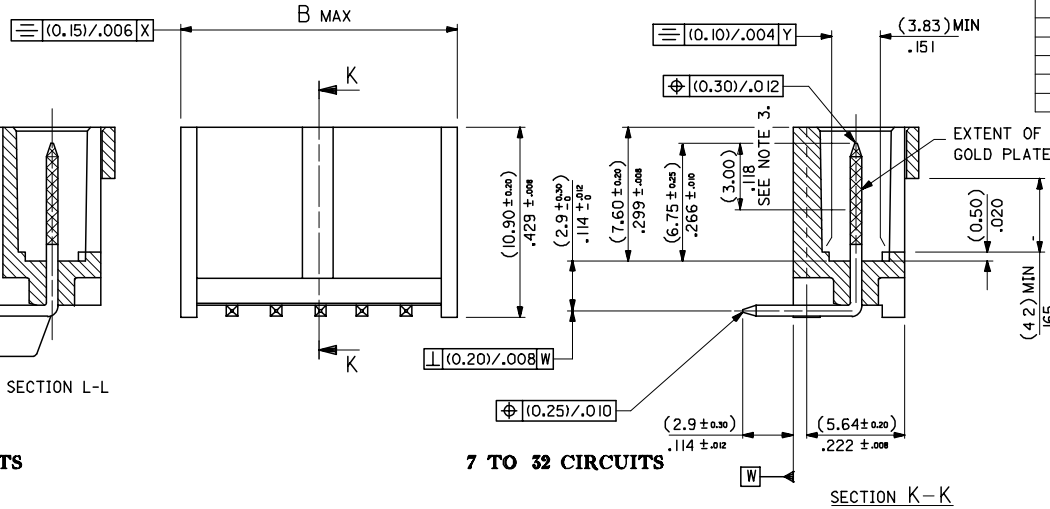

7 TO 32 CIRCUITS

SECTION K-K

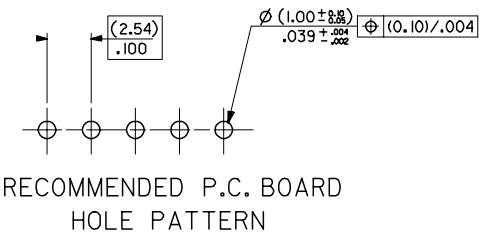

RECOMMENDED P.C. BOARD HOLE PATTERN

No. OF CKTS	DIM A	DIM B	DIM C
1		( 5.89 ) / .232	( 4.06 ) / .160
2	( 2.54 ) / .100	( 8.43 ) / .332	( 6.60 ) / .260
3	( 5.08 ) / .200	( 10.97 ) / .432	( 9.14 ) / .360
4	( 7.62 ) / .300	( 13.51 ) / .532	( 11.68 ) / .460
5	( 10.16 ) / .400	( 16.05 ) / .632	( 14.22 ) / .560
6	( 12.70 ) / .500	( 18.59 ) / .732	( 16.76 ) / .660
7	( 15.24 ) / .600	( 21.13 ) / .832	( 19.30 ) / .760
8	( 17.78 ) / .700	( 23.67 ) / .932	( 21.84 ) / .860
9	( 20.32 ) / .800	( 26.21 ) / 1.032	( 24.38 ) / .960
10	( 22.86 ) / .900	( 28.75 ) / 1.132	( 26.92 ) / 1.060
11	( 25.40 ) / 1.000	( 31.29 ) / 1.232	( 29.46 ) / 1.160
12	( 27.94 ) / 1.100	( 33.83 ) / 1.332	( 32.00 ) / 1.260
13	( 30.48 ) / 1.200	( 36.37 ) / 1.432	( 34.54 ) / 1.360
14	( 33.02 ) / 1.300	( 38.91 ) / 1.532	( 37.08 ) / 1.460
15	( 35.56 ) / 1.400	( 41.45 ) / 1.632	( 39.62 ) / 1.560
16	( 38.10 ) / 1.500	( 43.99 ) / 1.732	( 42.16 ) / 1.660
17	( 40.64 ) / 1.600	( 46.53 ) / 1.832	( 44.70 ) / 1.760
18	( 43.18 ) / 1.700	( 49.07 ) / 1.932	( 47.24 ) / 1.860
19	( 45.72 ) / 1.800	( 51.61 ) / 2.032	( 49.78 ) / 1.960
20	( 48.26 ) / 1.900	( 54.15 ) / 2.132	( 52.32 ) / 2.060
21	( 50.80 ) / 2.000	( 56.69 ) / 2.232	( 54.86 ) / 2.160
22	( 53.34 ) / 2.100	( 59.23 ) / 2.332	( 57.40 ) / 2.260
23	( 55.88 ) / 2.200	( 61.77 ) / 2.432	( 59.94 ) / 2.360
24	( 58.42 ) / 2.300	( 64.31 ) / 2.532	( 62.48 ) / 2.460
25	( 60.96 ) / 2.400	( 66.85 ) / 2.632	( 65.02 ) / 2.560
26	( 63.50 ) / 2.500	( 69.39 ) / 2.732	( 67.56 ) / 2.660
27	( 66.04 ) / 2.600	( 71.93 ) / 2.832	( 70.10 ) / 2.760
28	( 68.58 ) / 2.700	( 74.47 ) / 2.932	( 72.64 ) / 2.860
29	( 71.12 ) / 2.800	( 77.01 ) / 3.032	( 75.18 ) / 2.960
30	( 73.66 ) / 2.900	( 79.55 ) / 3.132	( 77.72 ) / 3.060
31	( 76.20 ) / 3.000	( 82.09 ) / 3.232	( 80.26 ) / 3.160
32	( 78.74 ) / 3.100	( 84.63 ) / 3.332	( 82.80 ) / 3.260

NOTES

- MATERIAL:-  
 - PIN\*- (0.635) / .025 SQ. BRASS WIRE.  
 - HOUSING\*- 15% GLASS FILLED POLYESTER  
 - UL 94 V-0 COLOUR BLACK
2. FOR PLATING VERSIONS SEE SHEET 4.  
 3. MEASUREMENT FOR MINIMUM PLATING THICKNESS  
 4. PRODUCT SPEC: PS-99020-0001  
 5. RECOMMENDED PCB THICKNESS 1.6mm

CIRCUIT 1 IDENTIFIED EC NO: E2008-0112 DRAWN: BIRNES 2007/09/10 CHKD: 2007/09/10 APPR: WALLACE 2007/09/11	QUALITY SYMBOLS ▽=0 ▽=0	GENERAL TOLERANCES (UNLESS SPECIFIED)	DIMENSION STYLE MM/IN	SCALE 5:1	DESIGN UNITS METRIC	THIRD ANGLE PROJECTION
	DESCRIPTION	4 PLACES ± --- ± --- 3 PLACES ± --- ± .004 2 PLACES ± 0.10 ± --- 1 PLACE ± --- ± --- ANGULAR ± 1/2°	DRAWN BY KS	DATE 1987/09/29	TITLE C-GRID 111 SINGLE ROW RIGHT ANGLE SHROUDED HEADER	
	DRAFT WHERE APPLICABLE MUST REMAIN WITHIN DIMENSIONS		CHECKED BY	DATE	MOLEX MOLEX INCORPORATED	
			APPROVED BY	DATE	MATERIAL NO. SDA-90136	SHEET NO. 3 OF 100
			THIS DRAWING CONTAINS INFORMATION THAT IS PROPRIETARY TO MOLEX INCORPORATED AND SHOULD NOT BE USED WITHOUT WRITTEN PERMISSION			

12 11 10 9 8 7 6 5 4 3 2 1

F

F

E

E

D

D

C

C

B

B

A

A

PART NUMBERS

NO. OF CKTS	PLATING TYPE A	PLATING TYPE E	PLATING TYPE F
1	90136-2101	90136-2201	90136-2301
2	▲ -2102	▲ -2202	▲ -2302
3	-2103	-2203	-2303
4	-2104	-2204	-2304
5	-2105	-2205	-2305
6	-2106	-2206	-2306
7	-2107	-2207	-2307
8	-2108	-2208	-2308
9	-2109	-2209	-2309
10	-2110	-2210	-2310
11	-2111	-2211	-2311
12	-2112	-2212	-2312
13	-2113	-2213	-2313
14	-2114	-2214	-2314
15	-2115	-2215	-2315
16	-2116	-2216	-2316
17	-2117	-2217	-2317
18	-2118	-2218	-2318
19	-2119	-2219	-2319
20	-2120	-2220	-2320
21	-2121	-2221	-2321
22	-2122	-2222	-2322
23	-2123	-2223	-2323
24	-2124	-2224	-2324
25	-2125	-2225	-2325
26	-2126	-2226	-2326
27	-2127	-2227	-2327
28	-2128	-2228	-2328
29	-2129	-2229	-2329
30	-2130	-2230	-2330
31	▼ -2131	▼ -2231	▼ -2331
32	90136-2132	90136-2232	90136-2332

NOTES

1.FOR ASSY SEE SHEET 3

2.FOR PLATING DETAILS SEE SDES 99000-0003

90136 - X X X X

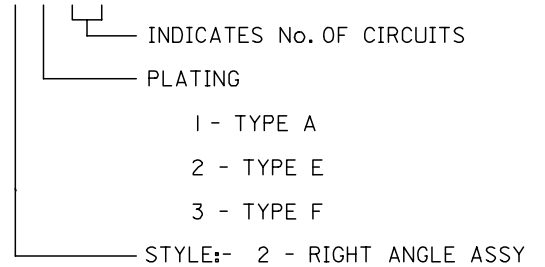

UPDATED TABLE EC NO: E2007-1001 DRWN:DBYRNES CHKD: APPR:EOMAHONY 2007/06/07 2007/06/07 2007/06/07	QUALITY SYMBOLS	GENERAL TOLERANCES (UNLESS SPECIFIED)	DIMENSION STYLE MM ONLY	SCALE ---	DESIGN UNITS METRIC	THIRD ANGLE PROJECTION
	▼=0 ◻=0	4 PLACES ±--- ±--- 3 PLACES ±--- ±--- 2 PLACES ±--- ±--- 1 PLACE ±--- ±--- ANGULAR ±---°	DRAWN BY DATE KS 1987/09/28 CHECKED BY DATE RD 1991/10/16 APPROVED BY DATE NW 1991/10/17	TITLE C-GRID SHRD HDR SR VT		
		DRAFT WHERE APPLICABLE MUST REMAIN WITHIN DIMENSIONS	MATERIAL NO. SEE CHART	MOLEX INCORPORATED SDA-90136		SHEET NO. 4 OF 8
			THIS DRAWING CONTAINS INFORMATION THAT IS PROPRIETARY TO MOLEX INCORPORATED AND SHOULD NOT BE USED WITHOUT WRITTEN PERMISSION			